



# Understanding poor soil fertility management under low inputs conditions in cereal cropping system in Mali

## Sub-activity MA1113-18

Bouba Traore et al

Sikasso, 11 -15, 2019



Outcome no.1 _ _	Output no. 1_1		Activity no.1_1_1_3								
<b>Sub-activity title</b>	Understanding poor soil fertility management under low inputs conditions in cereal cropping system in Mali										
<b>Location/sites for sub-activity</b>	Koutiala										
<b>Implementation timeframe (start/end date)</b>	2018 survey on nutrient flow at every 3 months for two years; March 2019-Testing Agroecological intensification option according to the result of nutrient balance; November 2018- collecting cotton biomass for producing smart above ground heap compost;										
<b>Deliverables</b>	<ol style="list-style-type: none"> <li>1. Mapping soil fertility by farm typology</li> <li>2. Survey on nutrient flow</li> <li>3. Smart composting with cotton stem</li> <li>4. Cost and benefit analysis micro dose application of composting</li> </ol>	<ol style="list-style-type: none"> <li>4. Draft paper on tackling soil fertility depletion by 2020</li> <li>5. 2 MSc thesis 2019, PhD draft 2020-2021</li> </ol>									
<b>S.I. domain and indicators for which data was collected – indicate metric and scale</b>	<ol style="list-style-type: none"> <li>1. Crop yield and biomass production at farm level</li> <li>2. Soil nutrient assessment (NPKSB), organic matter at farm level</li> <li>3. Food security</li> </ol>	<ol style="list-style-type: none"> <li>4. Nutrient balance profitability</li> <li>5. ---</li> <li>6. ---</li> </ol>									
<b>Research team and responsibilities</b>	<ol style="list-style-type: none"> <li>1. Bouba Traore (Farming system)</li> <li>2. Birhanu Zemadim (Team coordinator)</li> <li>3. Felix Badolo (Agro-economist)</li> </ol>	<ol style="list-style-type: none"> <li>4. Moumini Guindo</li> </ol>									
<b>Farming systems research perspective (how this work links with others)</b>	This work includes biophysical characteristics as well as socio-economic status of different farmers typology. It can be link to any other activity related to crop livestock integration approach under smallholder farming system										
<b>Estimated fund requirement</b>	Budget Line <table style="width: 100%; border-collapse: collapse;"> <tr> <td style="width: 15%;"></td> <td style="width: 35%; text-align: center;">ICRISAT</td> <td style="width: 35%; text-align: center;">AMEDD</td> <td style="width: 15%;"></td> </tr> <tr> <td>Total</td> <td style="text-align: center;">53360</td> <td style="text-align: center;">11,500</td> <td></td> </tr> </table>				ICRISAT	AMEDD		Total	53360	11,500	
	ICRISAT	AMEDD									
Total	53360	11,500									



2018 survey on nutrient flow at every 3 months for two years

Main Concept : “Units” and “Flows”

### “Units”

- household
- crops
- animals
- etc.

### “Flows”

- harvested products
- applied fertilizer
- leached N
- hired labor
- etc.

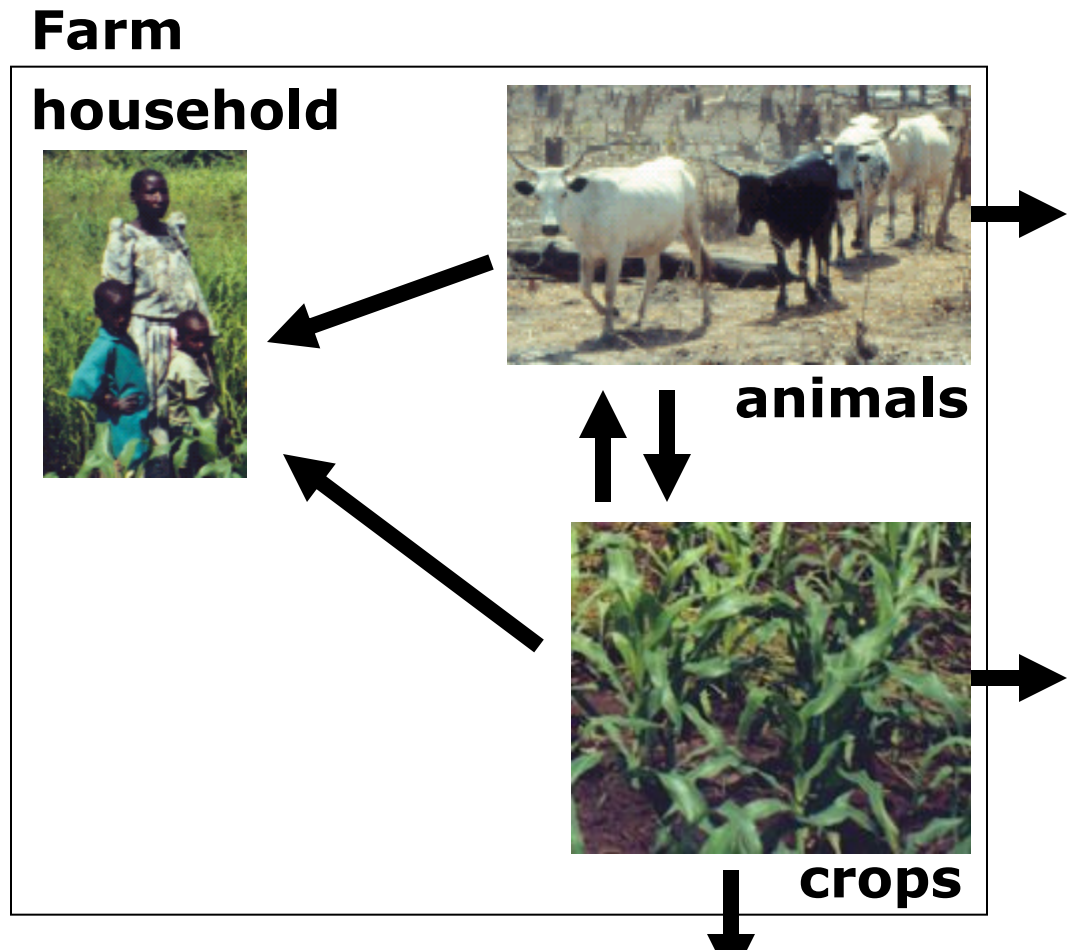



# Questionnaire structure

## Questionnaire

- Inventory (10 forms)
  - Farm
  - Household
  - FSUs, PPU, SPU, RU
- Monitoring (13 forms)
  - Flows
  - Herd growth
  - Animal confinement
  - Off-farm income

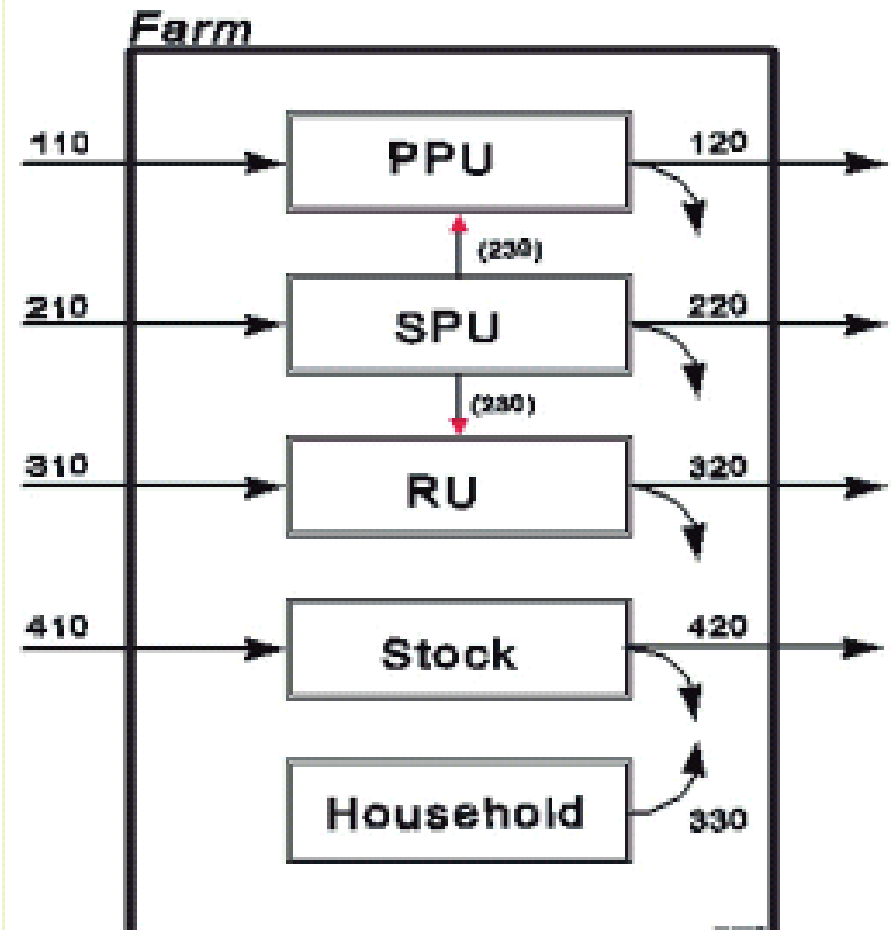

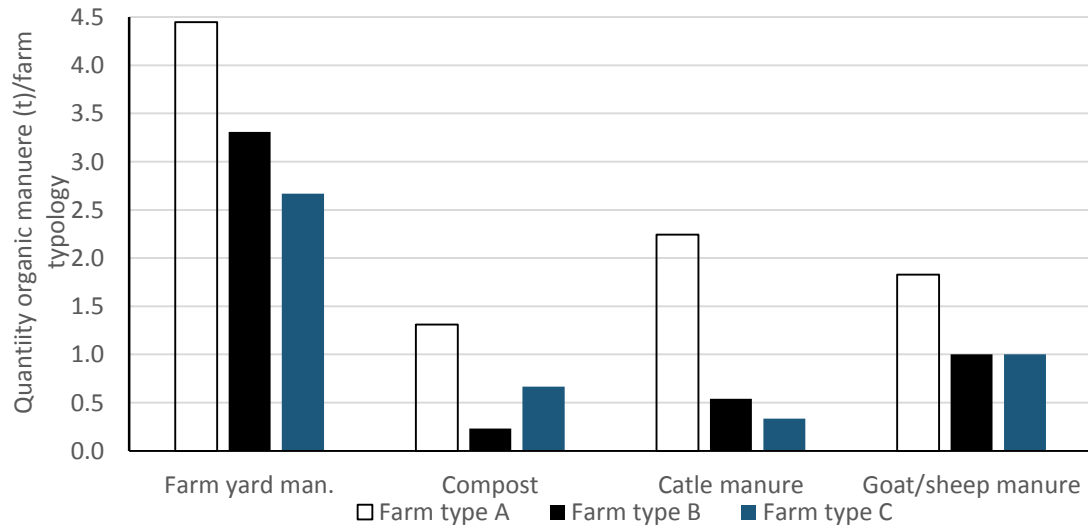
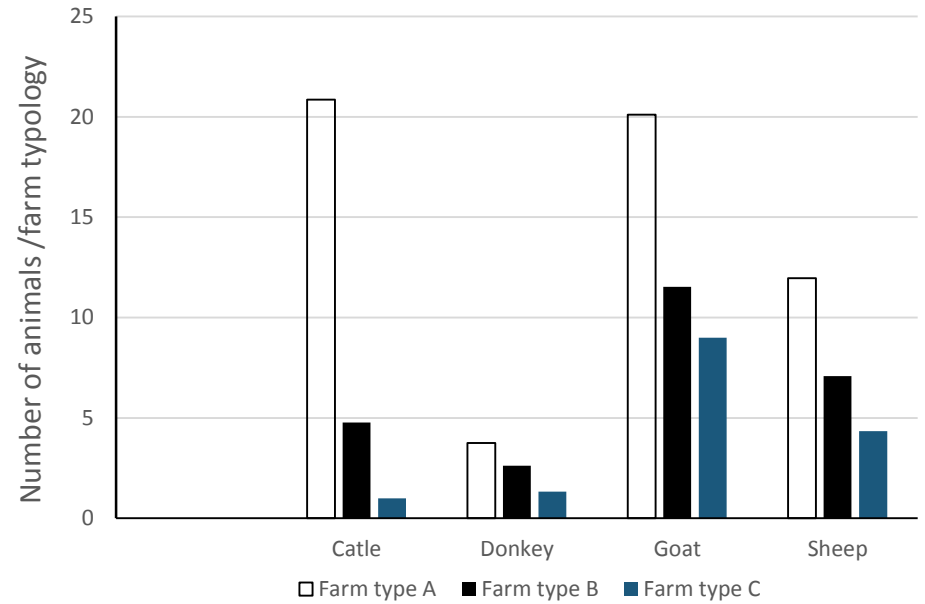
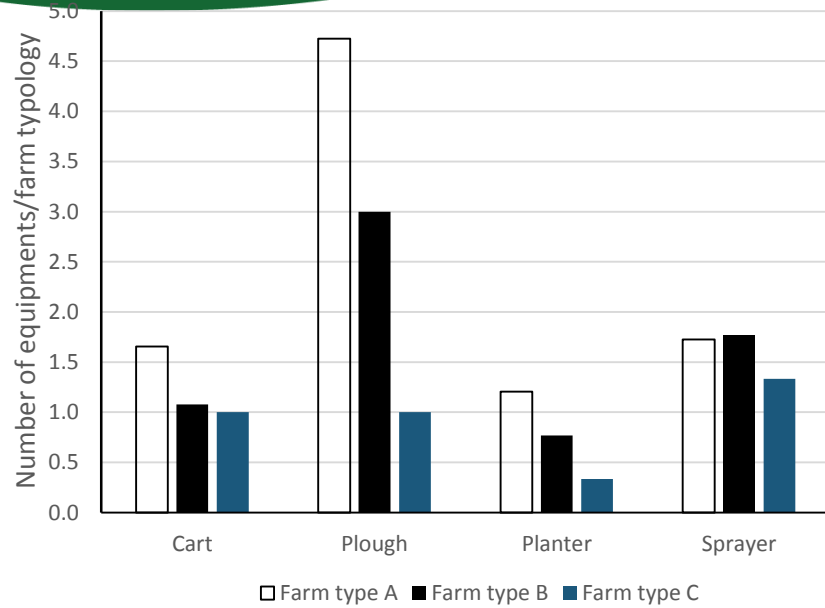

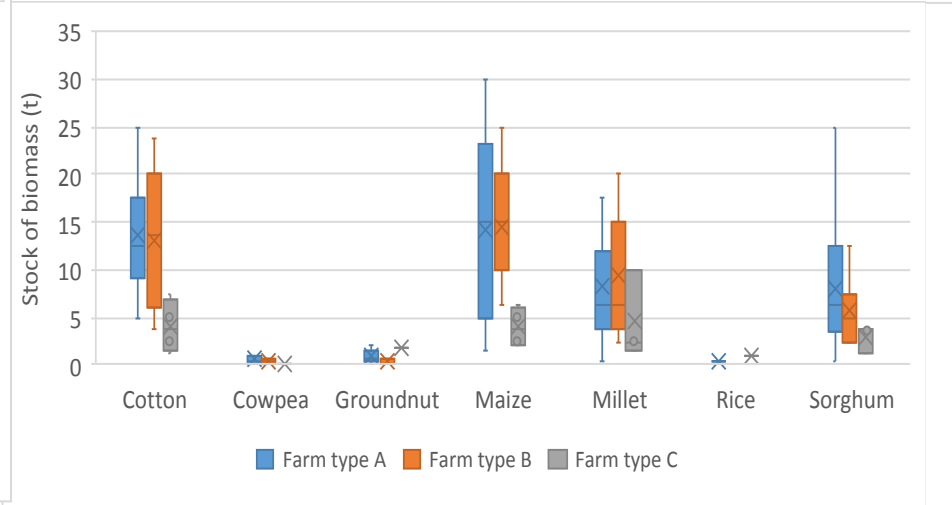
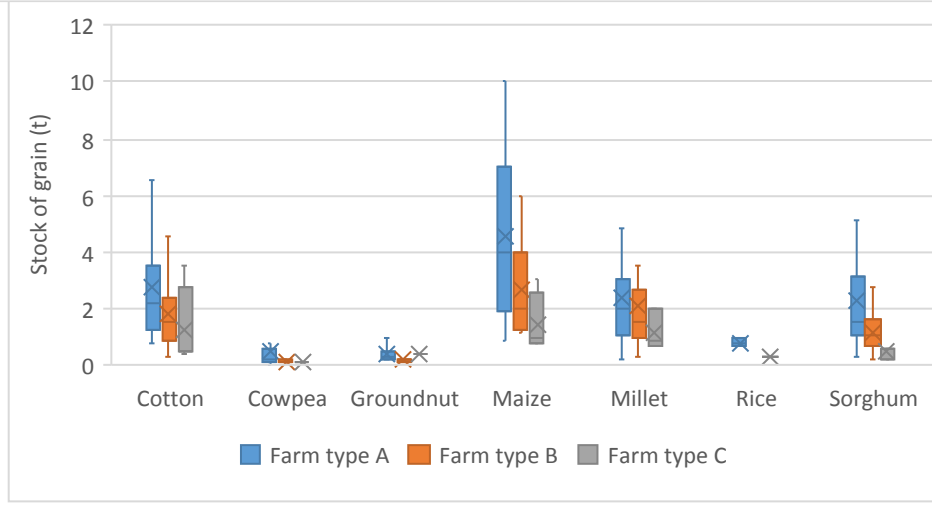
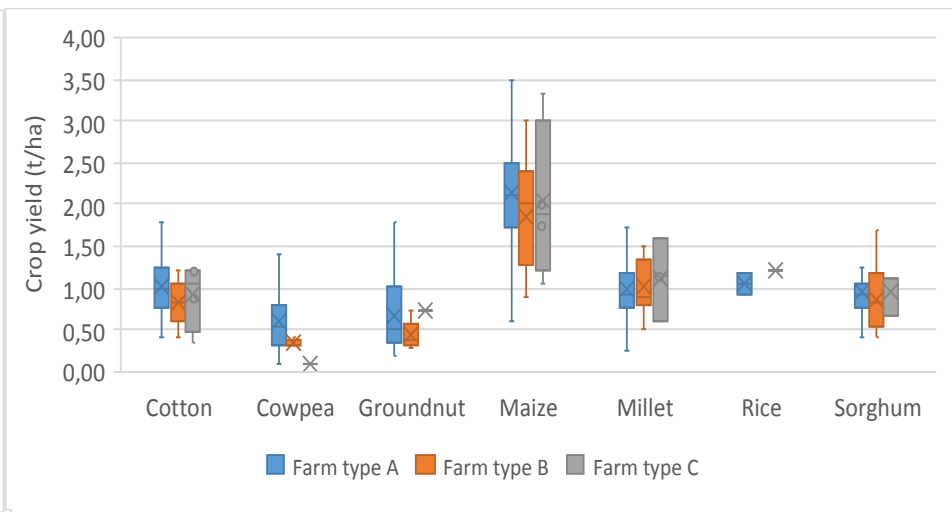
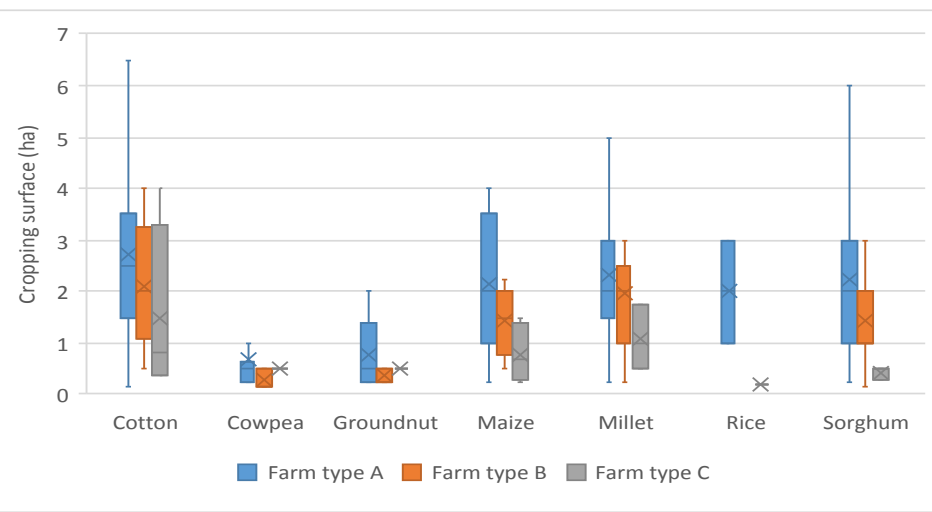

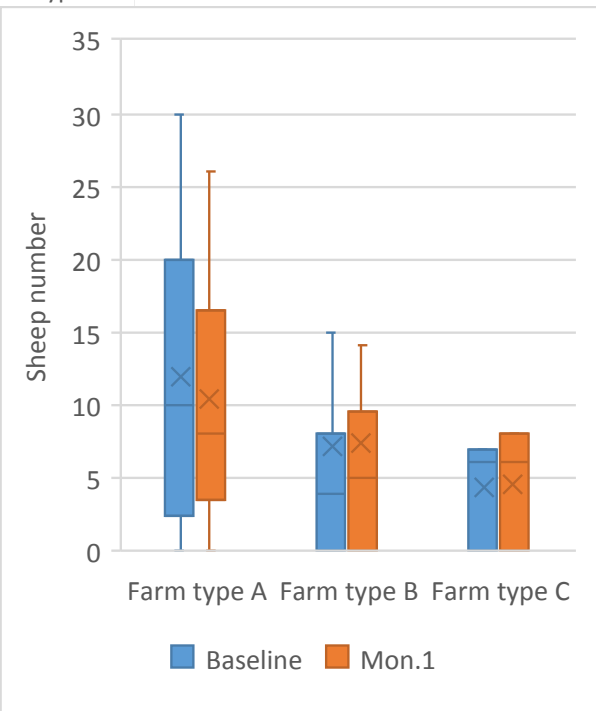
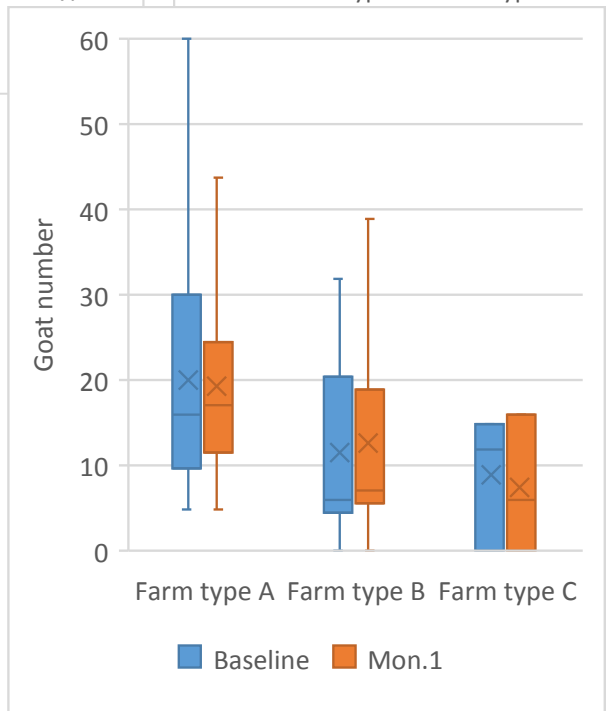
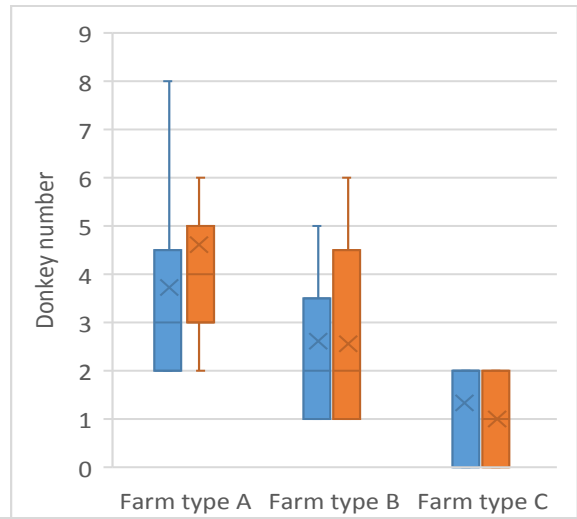
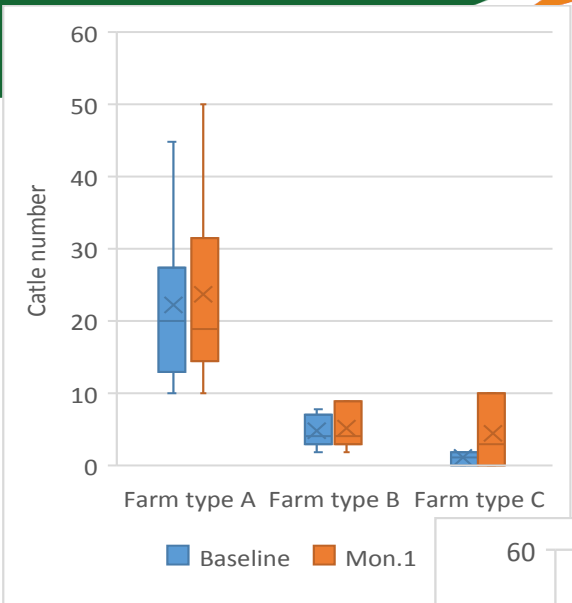

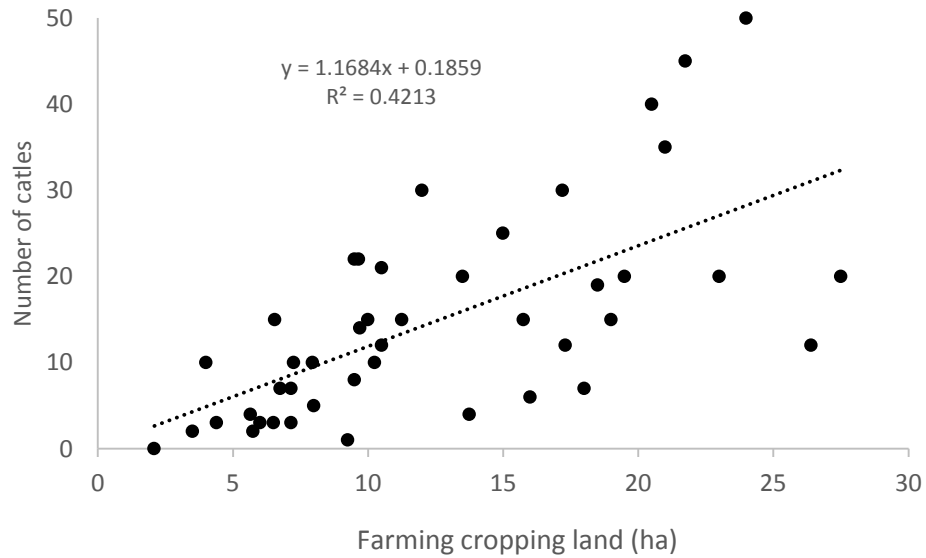
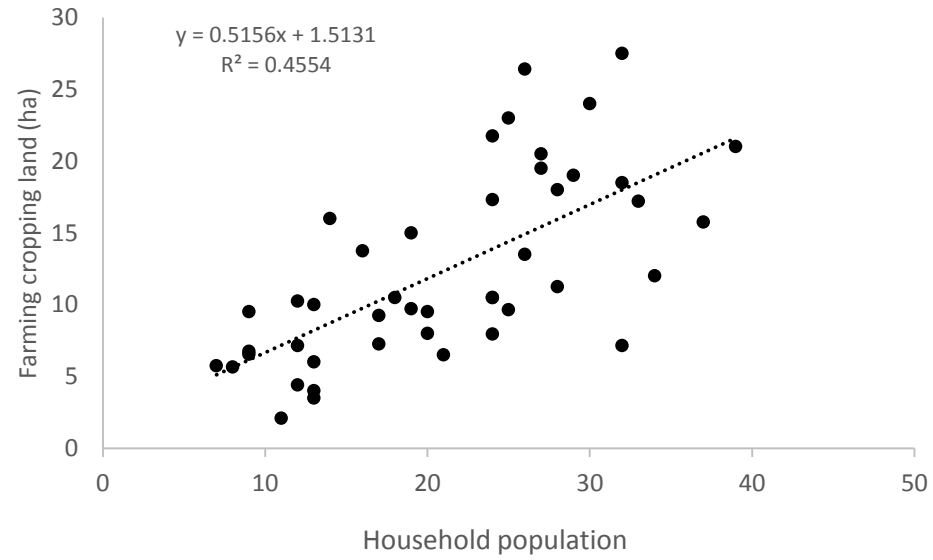
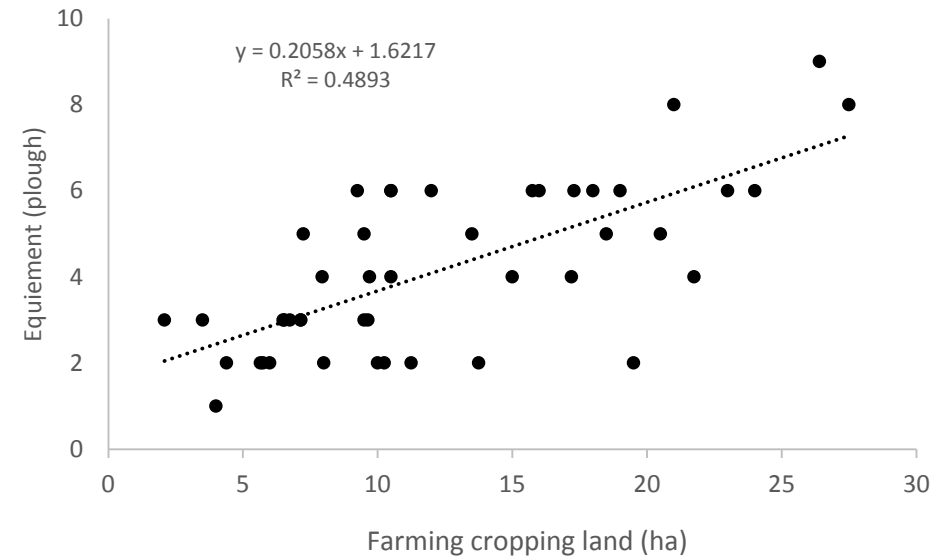





Assessing nutrient flows and balance under low soil fertility and low inputs conditions.

## NUTrient MONItoring

### Nutrient & economic balance of small-scale tropical farming systems

- IN 1: mineral fertilizers
- IN 2: organic manure
- IN 3: wet and dry deposition
- IN 4: biological Nitrogen fixation
- IN 5: sedimentation

In flows

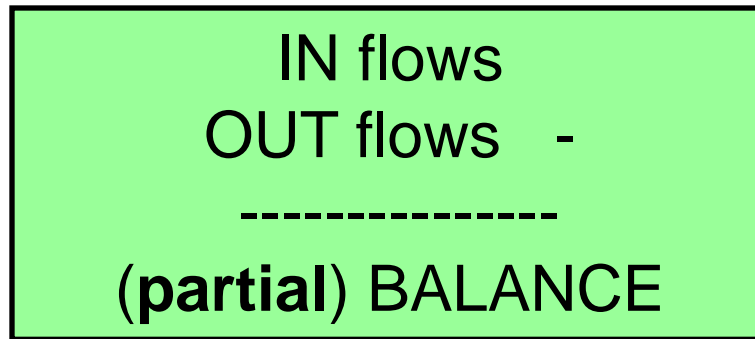
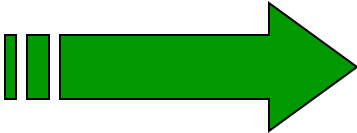

Out flows

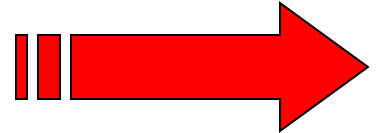

- OUT 1: removal harvested crop products
- OUT 2: removal crop residues
- OUT 3: leaching
- OUT 4: gaseous losses
- OUT 5: erosion







## Composting with cotton stem

Compost 1: 1 ton cotton stem  
+200 kg cattle manure + 50 kg  
dead leaves+ coal ash

Compost 2: 2 ton cotton stem +200  
kg Cattle manure + 50 kg dead  
leaves+ coal ash



- ❖ At farmer field, 45 farmers are producing either compost 1 or 2 and will be applicate using micodosing



# Thank You

*Africa Research in Sustainable Intensification for the Next Generation*

[africa-rising.net](http://africa-rising.net)



This presentation is licensed for use under the Creative Commons Attribution 4.0 International Licence.